



光电传感器

Photoelectric sensors



反射型 (Reflective type) EN18P: 200cm ; EN50 : 200cm

对射型 (Opposite type) EN18P: 2000cm EN50 : 2000cm

镜片反射型 (Polarizing lens reflective type) EN18P: 500cm ; EN50 : 1000CM



以人为本 品质时代

每个完美经典都是创新起点。

世人感叹奇迹，唯有开创者创造奇迹。

本 电气携创新科技与精湛工艺，

乘风破浪，引导安全工业驶入更美的境界。

Every perfect classic is a starting point for innovation.

The world laments the miracles and only the pioneers create miracles.

NATURE BEYOND Electric carries innovative technologies and exquisite craftsmanship.

Riding the wind and waves to guide the security industry into a more beautiful realm.

Brief Introduction

企业简介

上海本焯电气科技有限公司其前身是一家集设计开发、生产、销售于一体的专业的传感器的制造商。我公司拥有独立的研发部门，专业的生产团队，并吸取众家之长，所设计的产品在品质、外观均可与任何厂家媲美。

我们产品涵盖电感接近传感器、电容式接近传感器、霍尔传感器、光电传感器、固态继电器、固态调压器及开关电源。我们一直致力于通过不断研发和质量管理，以高品质和多种类的产品及优质的服务来满足用户的需要。

公司以完善的组织架构和技术实力，保证了生产效率，以高度的灵活性为客户提供优质的服务，大部分产品通过欧共体 CE 认证，并始终贯彻执行“今天的质量，明天的市场”的质量方针，使企业得到了飞速的发展。

qwifm 在中国已被业界公认为传感器行业的领导品牌，并日益成为全球工控领域的知名品牌。

Shanghai Nature Beyond Electric Technology Co.,LTD is a sensor manufacturer, specialized in research and development, production and marketing. We have independent department and technical office for research and development. We also manage to accumulate other companies' strong points so that the products could compare with others about both the quality and the outward appearances.

Our production mainly deals with 9 varieties of products, including inductive proximity switch, capacitance proximity switch, hall switch, photoelectric sensor, color mark sensor, solid state relay, solid state regulator and magnetic transducer. We have been dedicated to improving the management of both technical and quality development as well as our services.

By sticking to the quality guideline that Today's Quality Should be the Assurance of Tommorrow's Market and with the efforts of the whole staff, our company has got the international quality approvals by ISO9001:2000 system and has developed the products into the advanced standard of the world with majority of them having gained CE approvals by European Community.

QWIFM, has been the leading brand in sensor market and gained its global reputation among industrial areas.

Contents

目录

光电、电压传感器

EN 系列光电传感器简介

EN18P 漫反射型长距离引线式光电传感器

EN18P 镜面反射型长距离引线式光电传感器

EN18P 漫反射型长距离接插件式光电传感器

EN18P 对射型长距离引线式光电传感器

EN18P 镜面反射型长距离接插件式光电传感器

EN18P 对射型长距离接插件式光电传感器

EN50 系列长距离宽电压系列传感器

EN50 系列长距离直流电压系列传感器

EN50 系列标准距离宽电压系列传感器

EN50 系列标准距离直流电压系列传感器

TD 系列附件

Photoelectric, voltage sensors

Brief Introduction of EN Series Photoelectric Sensor

EN18P Diffused Type Long Distance Cable Type Photoelectric Sensor

EN18P Through beam Type Long Distance Cable Type Photoelectric Sensor

EN18P Diffused Type Long Distance Cable Type Photoelectric Sensor With Connector

EN18P Retroreflective Long Distance Cable Type Photoelectric Sensor

EN18P Retroreflective Long Distance Cable Type Photoelectric Sensor With Connector

EN18P Through beam Type Long Distance Cable Type Photoelectric Sensor With Connector

EN50 Series Long Distance wide Voltage series sensor

EN50 Series Long Distance DC Voltage series sensor

EN50 Series Standard Distance wide Voltage series sensor

EN50 Series Standard distance DC Voltage series sensor

TD Series Electrical Accessories

EN 系列 光电传感器 EN Series Photoelectric Sensor

光电传感器概念

光电传感器是利用光线检测物体的传感器的统称，是由传感器的发射部分发射光信号并经检测物体的反射、阻隔和吸收，再被接受部分检测并转换为相应电信号来实现控制的装置。

光电传感器特点

- 非接触式检测，传感器使用寿命长，对被检测物无损害。
- 适用于长距离检测，用途广泛。
- 适用的被检测物种类繁多，对光线传播有影响的物体均可。
- 响应频率高，适用于高速流水线检测使用。
- 检测精度高，能用于不同的色彩分辨。
- 采用自主研发的 IC，抗强光干扰。

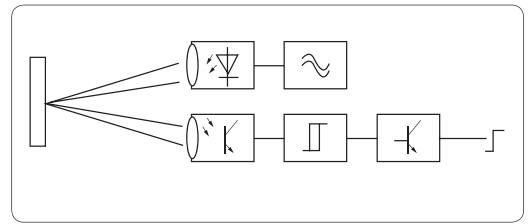

PHOTOELECTRIC SENSOR CONCEPT

Photoelectric sensor is a sensor that uses light to detect objects collectively, the light signal emitted by the sensor by detecting objects it shot, block and absorb longer accepted part of the detected and converted into corresponding electrical signal to the control device.

CHARACTERISTICS OF PHOTOELECTRIC SENSORS

- Non-contact detection, long sensing life, no damage to the objects to be detected.
- Suitable for long-distance detection of a wide range of uses.
- Applicable to a variety of subjects, also suitable to the objects which may affect ray propagating.
- High frequency response, suitable for the use of the high speed line detection.
- high detection precision, different colors can be used to distinguish.
- Use IC of independent research and development, Anti-glare interference.

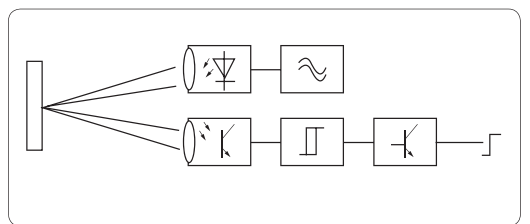

光电传感器型号构成及含义 / MODEL COMPOSITION AND DEFINITION OF INFRARED RAY PHOTOELECTRIC SWITCH.

EN 18P - D1 T 10 N A / □
1 2 3 4 5 6 7 8

编号 N.o	构成 Composition	代码及含义 Code and definition
1	基本形式 Basic form	EN: 第三代光电式传感器 (远距离) ENO: 激光传感器 EN: Third generation photoelectric sensor(Long distance)
2	外形编号 Outward appearance code	M18: 金属螺纹式外形 M18 × 1 18M: 短金属外壳 M18 × 1 18P: 塑料外壳 M18 × 1 M18: Metal thread type M18 × 1 18M:Short metal type M18 × 1 18P:Plastic shell M18 × 1
3	工作电压 Working voltage	D1:12-24VDC(10-30VDC) D2:5-24VDC D3:6-36VDC D4:10-60VDC D0: 特殊电压 Special voltage A1:20-250VAC A2:90-250VAC U:24-240VDC 36-240VAC
4	检测方式 Detection way	T: 漫反射型 (扩散反射型) S: 反馈反射型 (镜面反射型) E: 对射型接收器 E1: 对射型发射器 U: 槽型 Y: 背景抑制型 T:diffused reflection type(scattered reflection type) S:feedback reflection type mirror(mirror reflection type) E:correlation type E1:correlation type U:Groove type
5	检测距离 Detection distance	10:10cm 100:100cm 1000:1000cm
6	输出形式 Output form	N: NPN 负逻辑输出 P: PNP 正逻辑输出 L: 交流二线输出 J: 继电器触点输出 N: NPN P: PNP L: AC two-wire output J: Relay output
7	输出状态 Output state	A: 常开 B: 常闭 C: 常开 + 常闭 A: Normally open B: Normally close C: Normally open+normally close
8	引线长度 Lead length	无: 2M 5: 5m 15: 15m W: 弯插引线 Z: 直插引线 NO: 2M 5: 5m 15: 15m W: Bending-plug cable Z: Straight-plug cable

例 Case: EN18P-DIT10NA 例如: For example: EN18P-DIT10NA

表示: EN18P 塑料圆柱形 DC10-30V 工作电压, 漫反射型, 检测距离为 10cm,NPN(负逻辑) 敞开式的红外线光电传感器。

The model indicates the infrared ray photoelectric switch of M18 cylinder shape, DC 10-30V working voltage, diffused reflection type, detection distance 10 cm, and NPN normally open type.

漫反射式光电传感器

漫反射式光电传感器是发射器和接收器置于一体，正常情况下接收器收不到发射器发出的光信号；当检测物通过时阻隔了光，并把光部分反射回来，接收器收到光信号，输出一个开关控制信号。

- 特点：
- 安装使用时不需要对齐光路
 - 节省安装使用空间
 - 安装接线简便
 - 检测区更大

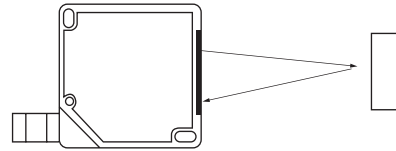

对射式光电传感器

对射式光电传感器是由独立发射器和接收器组成的光电传感器。由于发射器和接收器分离，传感器的检测距离加大。它的检测距离可达几米乃至几十米。使用时把发射器和接收器分别装在检测物通过路径的两侧，并必须将两者对准以建立光路，被检物通过时阻挡光路，接收器就动作输出一个开关控制信号。

- 特点：
- 安装使用时不需要对齐光路
 - 节省安装使用空间
 - 安装接线简便
 - 检测区域大



反馈反射式光电传感器 (镜面反射型)

反馈反射式光电传感器是把发射器和接收器装入同一个装置内，在其前方装一块反光板，利用反射原理完成光电控制作用的光电传感器。正常情况下，发射器发出的光被反光板发射回来被接收器收到；一旦光路被检测物挡住，接收器检测的光信号有变化，光电传感器就动作，输出一个开关控制信号。

- 特点：
- 安装使用时便于光路对齐
 - 相对于对射式光电传感器，节省安装使用空间
 - 安装接线简便
 - 不受被检物的形状、颜色和材质影响。

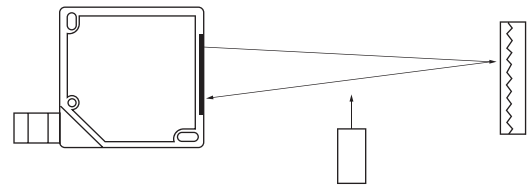

DIFFUSE PHOTOELECTRIC SENSOR

Diffuse reflection type photoelectric sensor is the transmitter and the receiver is placed integrally under normal circumstances, the receiver received less than the optical signal sent by the transmitter; when detection purified by blocking the light, and the light portion is reflected back, the receiver receives optical signal, and outputs a switch control signal.

- Features:
- Do not need to align with the optical path when installing
 - Saving installation space
 - Easy to install wiring
 - Large detection area

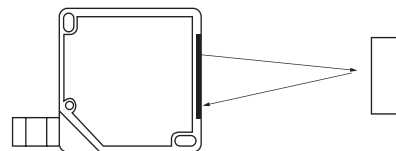

THROUGH BEAM TYPE PHOTOELECTRIC SENSOR

Beam photoelectric sensor is composed by an independent transmitter and receiver of the photoelectric sensor. Since the separation of the transmitter and receiver, the detection distance of the sensor to increase. Detection distance of up to a few meters or even tens of meters. To use the transmitter and receiver are mounted in the test object through the sides of the path, and must be aligned to create an optical path, when the subject was purified by blocking the light path, the receiver operation outputs a switching control signal.

- Features:
- Long-distance detection, precised detection
 - Can detect small objects
 - Free from impact of the shape, color and texture of the detected objects
 - Suitable for harsh working environment.



RETRO-REFLECTIVE PHOTOELECTRIC TRANSFER DEVICE

Retro-reflective photoelectric sensor is the transmitter and the receiver is loaded into the same apparatus, and a reflective plate mounted in front thereof, and the completion of the principle of reflection of the photoelectric control role. Under normal circumstances, the light emitted by the transmitter is reflection plate reflected back is received by the receiver, blocker once the optical path of the object to be detected, the receiver detects the optical signal changes, the operation of the photoelectric sensor, outputs a switch control signal.

- Features:
- Easy to align with the optican path when installing
 - Saving installation space when compared with the through beam type sensor
 - Easy to Instal wiring
 - Free from influence of the shape, color and texture of the detected objects.

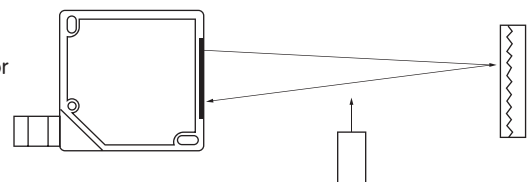

标准检测物:

用于确定漫反射式光电传感器检测距离的标准被检物，一般为无光泽纸 20cm × 20cm。

检测距离:

对于漫反射式（包括限定反射式）——在稳定检测条件下，传感器与标准检测物之间的距离。

对于对射式——在稳定检测条件下，发射器与接收器之间的距离。

对于反馈反射式（包括偏振反射式）——在稳定检测条件下，传感器与反光板之间的距离。

光源:

光电传感器的发射器通常使用以下几种光源:

红光 LED——可见光，可方便调整。

红外光 LED——高能量不可见光。

红色激光——可见光，其物理特性是用于小物体检测和大范围检测范围的理想选择。

qwifm 光电系列传感器主要是用红外光 LED 作为光源。

负载电流:

负载电流就是正常情况下经过传感器的工作电流。

压降:

压降是指传感器接通时在传感器两端或者输出端测量得到的电压。

消耗电流:

传感器工作状态下所需的电流。

漏电流:

传感器没有接通时，在其负载中残留的电流，称作漏电流。

DETECTION OF STANDARDS:

The diffuse reflection type photoelectric sensor detecting distance standards for determining the analyte. usually white matte's.

DETECTION DISTANCE:

For diffuse reflection(including defining a reflection-type) – in the stability testing conditions, the distance between the sensors with standard test object.

For radio – stability testing conditions, the distance between the transmitter and the receiver.

Retroreflective(including polarized reflectance) – stable testing conditions, the distance between the sensor and reflector plate.

LIGHT SOURCE:

The emitter of the photoelectric sensors typically use the following light sources:

Red LED–visible, can be easily adjusted.

Infrared LED–high–energy unvisivle light.

Red laser–visible light, its physical characteristics are the ideal choice for small detected body and a wide range of detection.

The Vanguard IFM brand photoelectric sensor using infrared LED as a light source.

LOAD CURRENT:

The load current is in the normal case, the working current through the sensor.

VOLTAGE DROP:

The voltage drop is when the sensor is working, the voltage obtained from the ends of the sensor or the output end.

CURRENT CONSUMPTION:

The needde current of the sensor in working state.

LEAKAGE CURRENT:

When the sensor is not turned on, the residual current in its load, is called leakage current.

回差:

检测体接近传感器感应面，触发传感器动作的感应距离与检测体远离传感器时动作复归时的复归距离之差。

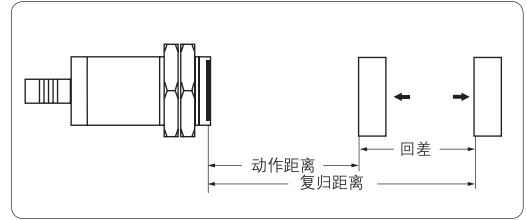

重复精度:

重复精度是指在外壳温度为 $(23 \pm 5)^\circ\text{C}$ ，相对湿度为随机的，供电电压为额定测量电压 $\pm 5\%$ ，在 8 个小时的范围内进行测量所产生的的有效作用距离的变化量。

开关频率:

开关频率是指每秒钟传感器动作的最大次数。

极性保护:

直流传感器防止极性接反的保护功能。

浪涌保护:

浪涌主要指的是电路中超出正常工作电压的瞬间过电压，它很可能使电路在浪涌的一瞬间烧坏。浪涌保护装置可以有效地吸收或分流突发的巨大能量，以保护设备免于受损。

短路保护:

如果极限电流超过的话，输出会周期性地封闭和释放，直至短路状态解除。

防护等级:

IP 防护等级系统是由 IEC (INTERNATIONAL ELECTROTECHNICAL COMMISSION) 所起草。将电器依其防尘防湿气之特性加以分级。这里所指的外物含工具，人的手指等均不可解除到电器内之带电部分，以免触电。IP 防护等级是由两个数字所组成。第 1 个数字代表产品防尘、防止外物侵入的等级，第 2 个数字表示产品防湿气、防水侵入的密闭程度，数字越大表示其防护等级越高。

BACKLASH:

The difference between the distances of proximity sensors detect body sensing surface, triggering the sensor action sensing distance away from the sensor detects body movements reversion reversion.

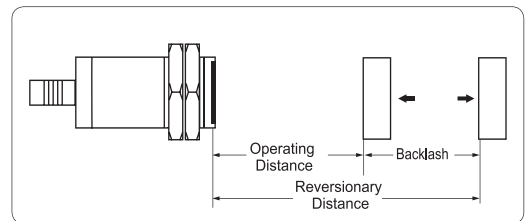

REPEATABILITY:

Repeated accuracy is in the housing temperature $(23 \pm 5)^\circ\text{C}$, the relative humidity is random, the supply voltage for rated measuring voltage $\pm 5\%$, the effective distance measuring the resulting amount of change in the range of 8 hours.

SWITCHING FREQUENCY:

The switching frequency is the maximum times of sensor operation per second.

POLARITY PROTECTION:

DC sensors prevent reversed polarity protection function.

SURGE PROTECTION:

The surge is transient overvoltage circuit in excess of the normal operating voltage, it is likely to make the circuit in the surge of the moment burned out. Surge protection device can effectively absorb the huge energy burst was sent streams, in order to protect the equipment from damage.

SHORT CIRCUIT PROTECTION:

If the limit current is exceeded, the output will be periodically closed and released, until the short-circuit state can be released.

PROTECTION CLASS:

IP protection class system is drafted by the IEC (INTERNATIONAL ELECTROTECHNICAL COMMISSION). Appliances according to their dustproof anti-moisture characteristics to grade. Referred to foreign objects including tools, fingers, etc. Do not touch the live parts of the electrical appliances to avoid electric shock. IP protection class is composed by two figures. The first figure represents the level of protection to prevent the intrusion of foreign objects, the second figure indicate the product against moisture, waterproof intrusion the airtight degree, the larger the figures are, the higher level of protection.

安装调试

漫反射式（包括限定反射式）

虽然灵敏度处在最大位置，调节时还是要依照周围环境的反射材料。把检测物放在检测范围内，将调节电位器调节到刚好检测到与最大检测距离的中间位置。

规格表中的检测距离是在检测目标为 100*100mm、200*200mm、300*300mm 的白色无光泽纸的条件下测得。

对射式

将发射器和接收器面对面安装，并连接电源。调节发射器和接收器的上下左右位置，使中心对正，使指示灯状态变化。可靠安装两者后并校对使其检测到目标。

反馈反射式（镜面反射型）

将传感器和反光板镜面对面安装后，连接电源。调节反射面的上下左右位置，传感器的指示灯状态变化。可靠安装两者后并校对使其检测到目标。

注意：如果并行使用两个以上光电传感器，它们之间的距离应大于 30mm，如果被检测物的反射率比反光板面更高，它会发生误动作，因此，在传感器和被检测物之间留有足够的空间，或把被检测物和光轴放置成 30-45 度的角度，或者考虑采用偏振反射式产品。

传感器连接方式

引线方式——以电缆引线连接
插件方式——通过接插件连接

DIFFUSE REFLECTION(INCLUDING LIMITED REFLECTION)

Although the sensitivity is in the maximum position, when adjusting or in accordance with the surrounding environment of a reflective material. The detector was placed within the detection range, the adjustment potentiometer is adjusted to exactly detect the intermediate position with the maximum detection distance. Specifications table in the dection distance is measured in the dection target of 100*100mm, 200*200mm, 300*300mm non-glossy paper.

THROUGH BEAM TYPE

Install the transmitter and the receiver face to face, and connect the power. Vertical and horizontal position adjustment of transmitter and receiver, center positive, so that the indicator status change. The reliable install both and proofread it to detect the target.

FEEDBACK-REFLECTIVE TYPE(MIRROR REFLECTION TYPE)

Sensor and reflector mirror face-to-face installation, connector to a power supply. Adjust the vertical and horizontal position of the reflecting surface, the sensor indicator status changes. And reliable installation both proofreading and make it to the target is detected.

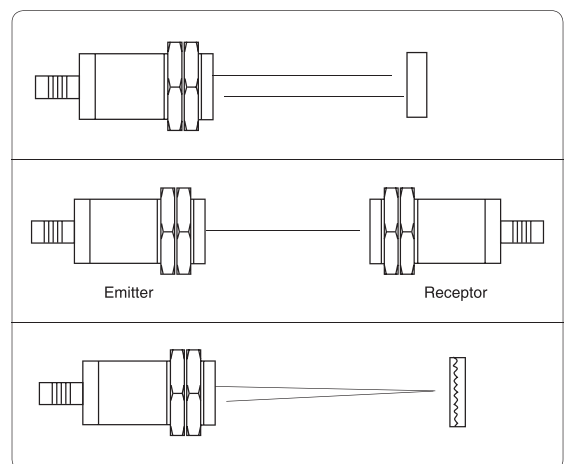
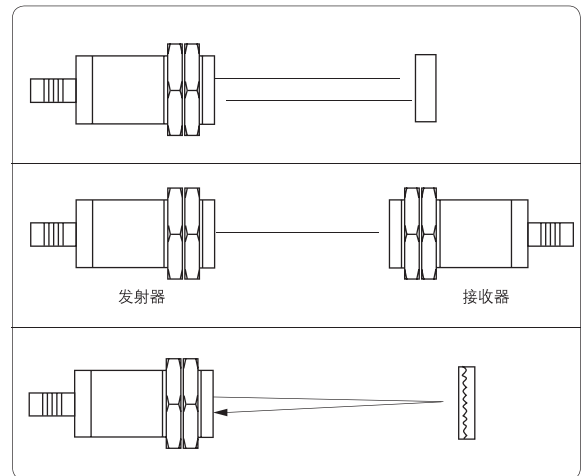

Note: If the AC line to use more than two photoelectric sensors, and the distance between themn should be greater than 30mm, the reflectance of the object if it is detected is higher than the reflector surface, it will maifunction, therefore, the sensor and the test object, enough space left between the object to be detected, and the optical axis is placed in an angle of 30-45 degrees, or consider the use of the polarized reflection-type products.

SENSOR CONNECTION WAYS

About way of leads——cable leads
About connection——connecting through socket

光电传感器应用实例

光电式传感器主要利用光电效应检测物体。在环境条件比较好，无粉尘污染的场所，可采用光电式传感器。光电式传感器有检测距离远，对被监测物无影响的特性，广泛用于电子行业、食品饮料行业、包装物流行业、机械、纺织印染、道闸控制系统等智能设备和自动化装备中起到侦测、计数、测速、信号传送等功能。

PHOTOELECTRIC SENSOR APPLICATION EXAMPLES

Photoelectric sensor photoelectric effect to detect objects. Better environmental conditions, no dust pollution occasions, can be used photoelectric sensor. Photoelectric sensor detection distance, had no effect on the characteristics of the test object, are widely used in the electronics industry, the food and beverage industry, packaging and logistics industry.

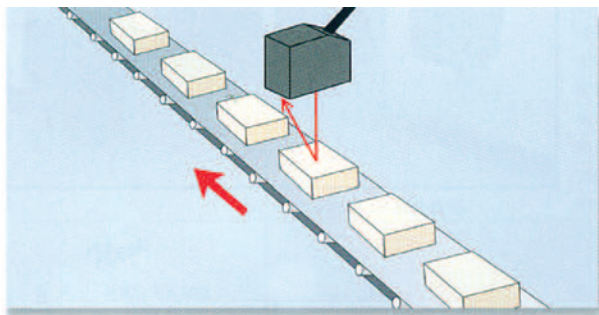

①检测滚动输送带上的被检测体……
不检测滚筒以及其他物体
(滚筒间距大时)

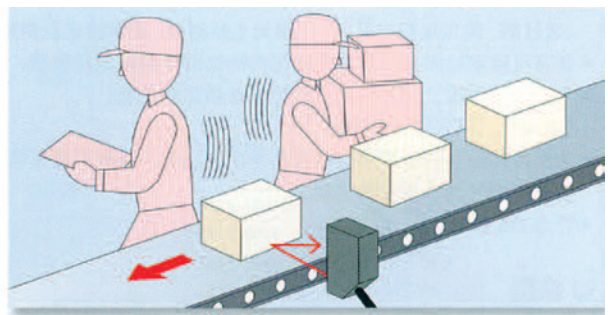

②仅检测PC板检查装置上的PC板……

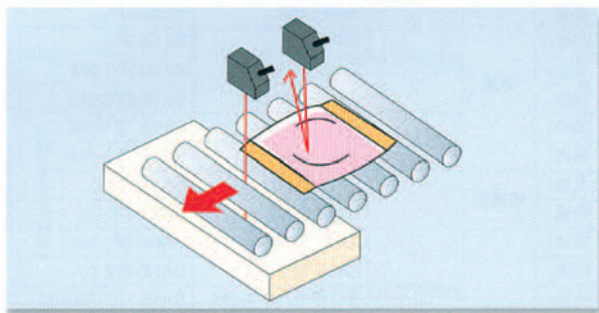

③生产线上的挑选系统……能否正确的挑选部品

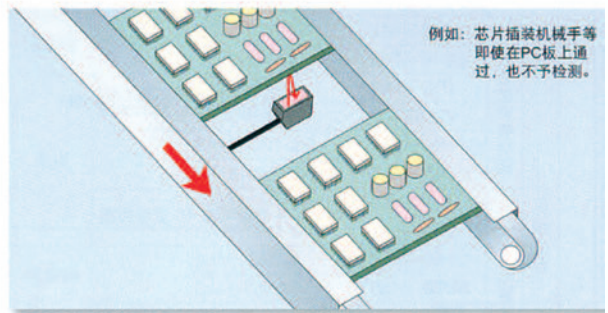

④通过检视与长度确认……识别长度不同的物体

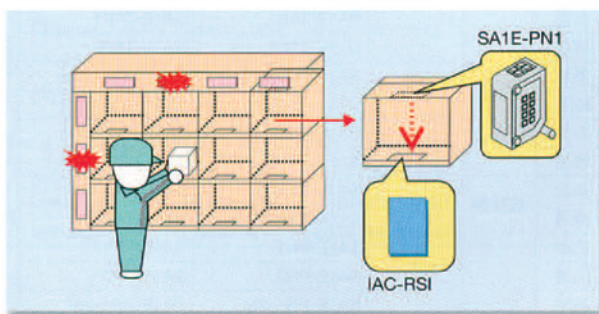

⑤检视有无颗粒状药物……药量是否正确

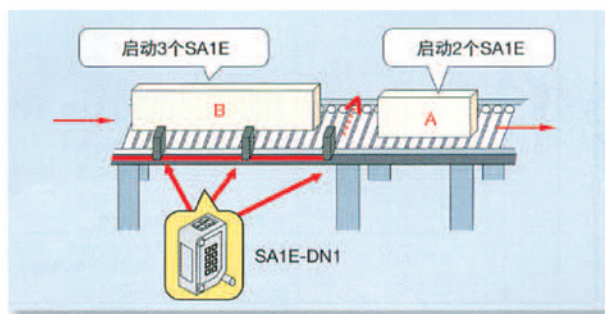

⑥控制电梯门的开关……有无障碍物

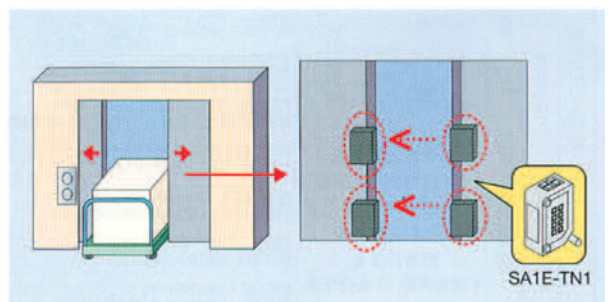
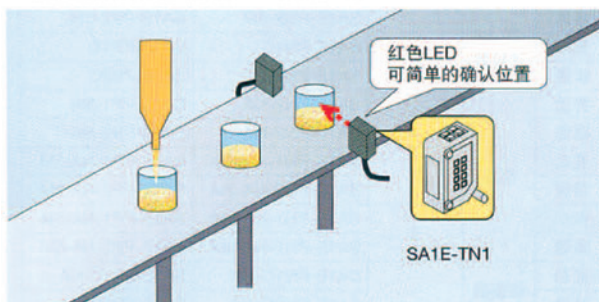

产品接线图示 / PRODUCT WIRING DIAGRAM

发射器 Transmitter		DC	AC/DC		
引线式 Leaded					
M8 连接器 M8 Connector					
端子连接 Terminal Connection					
DC 3 线 -DC three wire		NPN NO	NPN NC	PNP NO	PNP NC
引线式 Leaded					
M8 连接器 M8 Connector					
M12 连接器 M12 Connector					
AC 2 线 -AC two wire		SCR NO	SCR NC		
引线式 Leaded					
M12 连接器 M12 Connector					
NPN 可选 Optiona					
引线式 Leaded					
M12 连接器 M12 Connector					
NPN 可选 Optiona					
引线式 Leaded					
M12 连接器 M12 Connector					

EN 系列 光电传感器 EN Series Photoelectric Sensor

www.qwifm.com (China)
www.qwdhc.com(International)

产品接线图示 / PRODUCT WIRING DIAGRAM

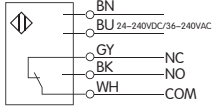
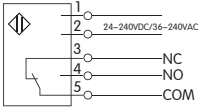
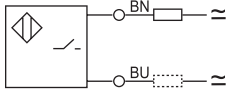
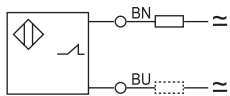
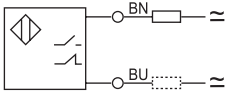
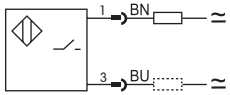
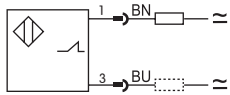
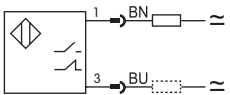
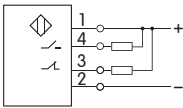
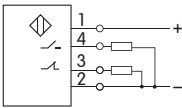
NPN/PNP 可选 Optiona				
AC/DC 5 线式 -Wire				
端子连接 Terminal Connection				
AC/DC	AC/DC 5 线式 -Wire			
				
AC / DC 2 线	NO	NC	NO/NC	
引线式 Leaded				
M12 连接器 M12 Connector				
端子连接 Terminal Connection				
DC	NPN NO+NC	PNP NO+NC		
				

产品说明图 / Explanation of the product

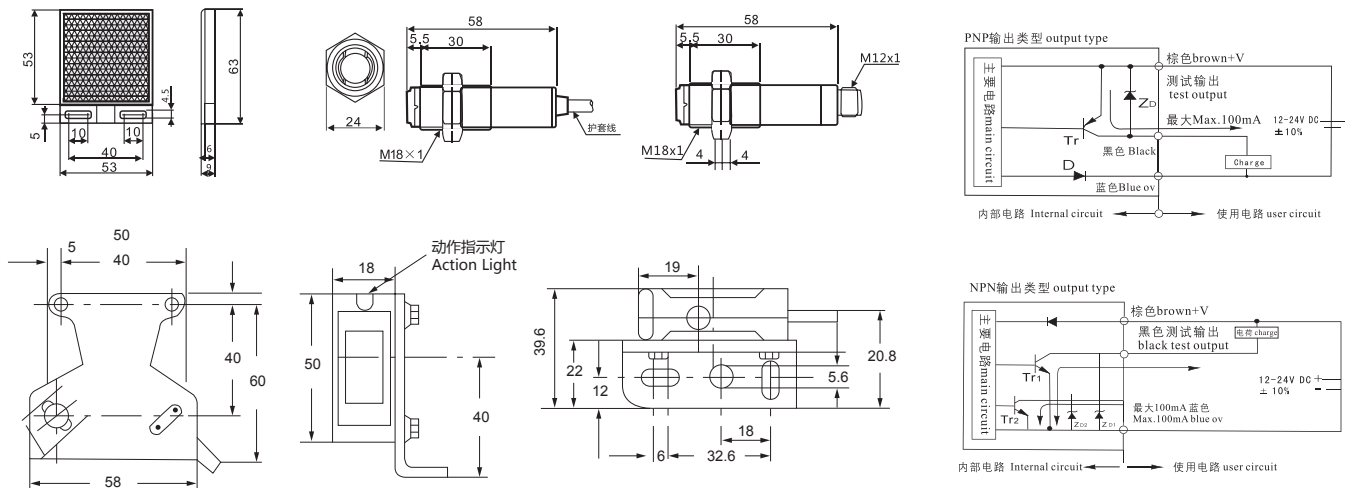

外形尺寸 Dimensions: M18 × 1 × 58



- 螺纹柱状光电传感器
- 具有光电-IC 技术
- 带灵敏度调节器
- 同时拥有领先的两项顶尖技术专利
- Threaded cylindrical photoelectric sensor
- Long life
- Photo-IC technology
- High Anti-Glare interference
- With sensitivity adjustment
- 长寿命
- 抗强光干扰
- 国际时尚款式

产品规格 / Specifications

产品型号		EN18P-DIT □□□			
检测方式		漫反射型			
检测距离		50cm	100cm	200cm	
检测物体		非透明体、半透明体、透明体			
型号	负逻辑	常开	EN18P-DIT50NA	EN18P-DIT100NA	EN18P-DIT200NA
		常闭	EN18P-DIT50NB	EN18P-DIT100NB	EN18P-DIT200NB
		一开一闭	EN18P-DIT50NC	EN18P-DIT100NC	EN18P-DIT200NC
型号	正逻辑	常开	EN18P-DIT50PA	EN18P-DIT100PA	EN18P-DIT200PA
		常闭	EN18P-DIT50PB	EN18P-DIT100PB	EN18P-DIT200PB
		一开一闭	EN18P-DIT50PC	EN18P-DIT100PC	EN18P-DIT200PC
标准检测物		无光泽白板纸 20cm × 20cm			
响应时间		无移动和复位小于 1ms			
电源电压		12-24VDC(10-30V)			
光源		红光 LED 660nm/ 红外线 880nm			
使用温度范围		-25℃ ~ 55℃ 没有结冰和结露			
产品标准		GB/T14048.10-2016			
保护结构		IP66(IEC 规格)			
材质		外壳: 塑料 镜头盖: 丙烯酸树脂 镜头: 丙烯酸树脂			
受光面照度		白炽灯: 小于 3000LUS. 阳光: 小于 11000LUS.			

Product model		EN18P-DIT □□□			
Type		Diffuse type			
Detecting distance		50cm	100cm	200cm	
Detecting target		Transparent, Translucent, Opaque materials			
Model	NPN	NO	EN18P-DIT50NA	EN18P-DIT100NA	EN18P-DIT200NA
		NC	EN18P-DIT50NB	EN18P-DIT100NB	EN18P-DIT200NB
		NO+NC	EN18P-DIT50NC	EN18P-DIT100NC	EN18P-DIT200NC
Model	PNP	NO	EN18P-DIT50PA	EN18P-DIT100PA	EN18P-DIT200PA
		NC	EN18P-DIT50PB	EN18P-DIT100PB	EN18P-DIT200PB
		NO+NC	EN18P-DIT50PC	EN18P-DIT100PC	EN18P-DIT200PC
Standard sensing object		Matte white board paper 20cm × 20cm			
Response time		Move and reset less than 1ms			
Power supply		12-24VDC(10-30V)			
Light		Red light LED 660nm/ Infrared 880nm			
Ambient Temperature		-25℃ ~ +55℃ without icing and condensation			
Product Standards		GB/T14048.10-2016			
Protection		IP66(IEC Specification)			
Material		Shell: Plastic, Lens cap: Acrylic, Lens: Acrylic			
Ambient illumination		Lamp: Less than 3000LUS. Sunlight: Less than 11000LUS.			

长距离引线式光电传感器

EN18P Retroreflective Long Distance Cable Type
Photoelectric Sensor

外形尺寸 Dimensions: M18 × 1 × 58

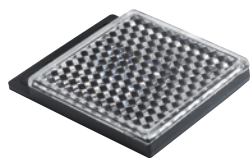

- 螺纹柱状光电传感器
- 具有光电-IC 技术
- 带灵敏度调节器
- 同时拥有领先的两项顶尖技术专利
- Threaded cylindrical photoelectric sensor
- Long life
- Photo-IC technology
- High Anti-Glare interference
- With sensitivity adjustment
- 长寿命
- 抗强光干扰
- 国际时尚款式

产品规格 / Specifications

产品型号	EN18P-D1S □□□				
检测方式	镜面反射型				
检测距离	200cm	400cm	500cm		
检测物体	Φ 60mm 以上的非透明体				
型号	负逻辑	常开	EN18P-D1S200NA	EN18P-D1S400NA	EN18P-D1S500NA
		常闭	EN18P-D1S200NB	EN18P-D1S400NB	EN18P-D1S500NB
		一开一闭	EN18P-D1S200NC	EN18P-D1S400NC	EN18P-D1S500NC
型号	正逻辑	常开	EN18P-D1S200PA	EN18P-D1S400PA	EN18P-D1S500PA
		常闭	EN18P-D1S200PB	EN18P-D1S400PB	EN18P-D1S500PB
		一开一闭	EN18P-D1S200PC	EN18P-D1S400PC	EN18P-D1S500PC
标准检测物	无光泽白板纸 20cm × 20cm				
响应时间	无移动和复位小于 1ms				
电源电压	12-24VDC(10-30V)				
光源	红光 LED 660nm/ 红外线 880nm				
使用温度范围	-25℃ ~ 55℃ 没有结冰和结露				
产品标准	GB/T14048.10-2016				
保护结构	IP66(IEC 规格)				
材质	外壳: 塑料 镜头盖: 丙烯酸树脂 镜头: 丙烯酸树脂				
受光面照度	白炽灯: 小于 3000LUS. 阳光: 小于 11000LUS.				

Product model	EN18P-D1S □□□				
Type	Retroreflective				
Detecting distance	200cm	400cm	500cm		
Detecting target	Opaque materials of Min. Φ 60mm				
Model	NPN	NO	EN18P-D1S200NA	EN18P-D1S400NA	EN18P-D1S500NA
		NC	EN18P-D1S200NB	EN18P-D1S400NB	EN18P-D1S500NB
		NO+NC	EN18P-D1S200NC	EN18P-D1S400NC	EN18P-D1S500NC
Model	PNP	NO	EN18P-D1S200PA	EN18P-D1S400PA	EN18P-D1S500PA
		NC	EN18P-D1S200PB	EN18P-D1S400PB	EN18P-D1S500PB
		NO+NC	EN18P-D1S200PC	EN18P-D1S400PC	EN18P-D1S500PC
Standard sensing object	Matte white board paper 20cm × 20cm				
Response time	Move and reset less than 1ms				
Power supply	12-24VDC(10-30V)				
Light	Red light LED 660nm/ Infrared 880nm				
Ambient Temperature	-25℃ ~ +55℃ without icing and condensation				
Product Standards	GB/T14048.10-2016				
Protection	IP66(IEC Specification)				
Material	Shell: Plastic, Lens cap: Acrylic, Lens: Acrylic				
Ambient illumination	Lamp: Less than 3000LUS. Sunlight: Less than 11000LUS.				

长距离引线式光电传感器

EN18P Through beam Type Long Distance Cable Type
Photoelectric Sensor

外形尺寸 Dimensions: M18 × 1 × 58



- 螺纹柱状光电传感器
- 具有光电-IC 技术
- 带灵敏度调节器
- 同时拥有领先的两项顶尖技术专利
- Threaded cylindrical photoelectric sensor
- Long life
- Photo-IC technology
- High Anti-Glare interference
- With sensitivity adjustment
- 长寿命
- 抗强光干扰
- 国际时尚款式

产品规格 / Specifications

产品型号	EN18P-D1E1 □□□				
检测方式	对射型				
检测距离	500cm	1000cm	2000cm		
检测物体	Φ 60mm 以上的非透明体				
型号	负逻辑	常开	EN18P-D1E500NA	EN18P-D1E1000NA	EN18P-D1E2000NA
		常闭	EN18P-D1E500NB	EN18P-D1E1000NB	EN18P-D1E2000NB
		一开一闭	EN18P-D1E500NC	EN18P-D1E1000NC	EN18P-D1E2000NC
型号	正逻辑	常开	EN18P-D1E500PA	EN18P-D1E1000PA	EN18P-D1E2000PA
		常闭	EN18P-D1E500PB	EN18P-D1E1000PB	EN18P-D1E2000PB
		一开一闭	EN18P-D1E500PC	EN18P-D1E1000PC	EN18P-D1E2000PC
标准检测物	无光泽白板纸 20cm × 20cm				
响应时间	无移动和复位小于 1ms				
电源电压	12-24VDC(10-30V)				
光源	红光 LED 660nm/ 红外线 880nm				
使用温度范围	-25℃ ~ 55℃ 没有结冰和结露				
产品标准	GB/T14048.10-2016				
保护结构	IP66(IEC 规格)				
材质	外壳: 塑料 镜头盖: 丙烯酸树脂 镜头: 丙烯酸树脂				
受光面照度	白炽灯: 小于 3000LUS. 阳光: 小于 11000LUS.				

Product model	EN18P-D1E1 □□□				
Type	Opposite type (Through beam type)				
Detecting distance	500cm	1000cm	2000cm		
Detecting target	Opaque materials of Min. Φ 60mm				
Model	NPN	NO	EN18P-D1E500NA	EN18P-D1E1000NA	EN18P-D1E2000NA
		NC	EN18P-D1E500NB	EN18P-D1E1000NB	EN18P-D1E2000NB
		NO+NC	EN18P-D1E500NC	EN18P-D1E1000NC	EN18P-D1E2000NC
Model	PNP	NO	EN18P-D1E500PA	EN18P-D1E1000PA	EN18P-D1E2000PA
		NC	EN18P-D1E500PB	EN18P-D1E1000PB	EN18P-D1E2000PB
		NO+NC	EN18P-D1E500PC	EN18P-D1E1000PC	EN18P-D1E2000PC
Standard sensing object	Matte white board paper 20cm × 20cm				
Response time	Move and reset less than 1ms				
Power supply	12-24VDC(10-30V)				
Light	Red light LED 660nm/ Infrared 880nm				
Ambient Temperature	-25℃ ~ +55℃ without icing and condensation				
Product Standards	GB/T14048.10-2016				
Protection	IP66(IEC Specification)				
Material	Shell: Plastic, Lens cap: Acrylic, Lens: Acrylic				
Ambient illumination	Lamp: Less than 3000LUS. Sunlight: Less than 11000LUS.				

长距离接插件式光电传感器

EN18P Diffused Type Long Distance Cable Type
Photoelectric Sensor With Connector

外形尺寸 Dimensions: M18 × 1 × 58



- 螺纹柱状光电传感器
- 具有光电-IC 技术
- 带灵敏度调节器
- 同时拥有领先的两项顶尖技术专利
- Threaded cylindrical photoelectric sensor
- Long life
- Photo-IC technology
- High Anti-Glare interference
- With sensitivity adjustment
- 长寿命
- 抗强光干扰
- 国际时尚款式

产品规格 /Specifications

产品型号	EN18P-DIT □□□				
检测方式	漫反射型				
检测距离	50cm	100cm	200cm		
检测物体	非透明质、半透明体、透明体				
型号	负逻辑	常开	EN18P-DIT50NAW	EN18P-DIT100NAW	EN18P-DIT200NAW
		常闭	EN18P-DIT50NBW	EN18P-DIT100NBW	EN18P-DIT200NBW
		一开一闭	EN18P-DIT50NCW	EN18P-DIT100NCW	EN18P-DIT200NCW
型号	正逻辑	常开	EN18P-DIT50PAW	EN18P-DIT100PAW	EN18P-DIT200PAW
		常闭	EN18P-DIT50PBW	EN18P-DIT100PBW	EN18P-DIT200PBW
		一开一闭	EN18P-DIT50PCW	EN18P-DIT100PCW	EN18P-DIT200PCW
标准检测物	无光泽白板纸 20cm × 20cm				
响应时间	无移动和复位小于 1ms				
电源电压	12-24VDC(10-30V)				
光源	红光 LED 660nm/ 红外线 880nm				
使用温度范围	-25℃ ~ 55℃ 没有结冰和结露				
产品标准	GB/T14048.10-2016				
保护结构	IP66(IEC 规格)				
材质	外壳: 塑料 镜头盖: 丙烯酸树脂 镜头: 丙烯酸树脂				
受光面照度	白炽灯: 小于 3000LUS. 阳光: 小于 11000LUS.				

Product model	EN18P-DIT □□□				
Type	Diffuse type				
Detecting distance	50cm	100cm	200cm		
Detecting target	Transparent, Tanslucent, Opaque materials				
Model	NPN	NO	EN18P-DIT50NAW	EN18P-DIT100NAW	EN18P-DIT200NAW
		NC	EN18P-DIT50NBW	EN18P-DIT100NBW	EN18P-DIT200NBW
		NO+NC	EN18P-DIT50NCW	EN18P-DIT100NCW	EN18P-DIT200NCW
Model	PNP	NO	EN18P-DIT50PAW	EN18P-DIT100PAW	EN18P-DIT200PAW
		NC	EN18P-DIT50PBW	EN18P-DIT100PBW	EN18P-DIT200PBW
		NO+NC	EN18P-DIT50PCW	EN18P-DIT100PCW	EN18P-DIT200PCW
Standard sensing object	Matte white board paper 20cm × 20cm				
Response time	Move and reset less than 1ms				
Power supply	12-24VDC(10-30V)				
Light	Red light LED 660nm/ Infrared 880nm				
Ambient Temperature	-25℃ ~ +55℃ without icing and condensation				
Product Standards	GB/T14048.10-2016				
Protection	IP66(IEC Specification)				
Material	Shell: Plactic, Lens cap: Acrylic, Lens: Acrylic				
Ambient illumination	Lamp: Less than 3000LUS. Sunlight: Less than 11000LUS.				

长距离接插件式光电传感器

EN18P Retroreflective Long Distance Cable Type
Photoelectric Sensor With Connector

外形尺寸 Dimensions: M18 × 1 × 58



- 螺纹柱状光电传感器
- 具有光电-IC 技术
- 带灵敏度调节器
- 同时拥有领先的两项顶尖技术专利
- Threaded cylindrical photoelectric sensor
- Long life
- Photo-IC technology
- High Anti-Glare interference
- With sensitivity adjustment
- 长寿命
- 抗强光干扰
- 国际时尚款式

产品规格 / Specifications

产品型号	EN18P-D1S □□ W(Z)				
检测方式	镜面反射型				
检测距离	200cm	400cm	500cm		
检测物体	Φ 60mm 以上的非透明体				
型号	负逻辑	常开	EN18P-D1S200NAW	EN18P-D1S400NAW	EN18P-D1S500NAW
		常闭	EN18P-D1S200NBW	EN18P-D1S400NBW	EN18P-D1S500NBW
		一开一闭	EN18P-D1S200NCW	EN18P-D1S400NCW	EN18P-D1S500NCW
型号	正逻辑	常开	EN18P-D1S200PAW	EN18P-D1S400PAW	EN18P-D1S500PAW
		常闭	EN18P-D1S200PBW	EN18P-D1S400PBW	EN18P-D1S500PBW
		一开一闭	EN18P-D1S200PCW	EN18P-D1S400PCW	EN18P-D1S500PCW
标准检测物	无光泽白板纸 20cm × 20cm				
响应时间	无移动和复位小于 1ms				
电源电压	12-24VDC(10-30V)				
光源	红光 LED 660nm/ 红外线 880nm				
使用温度范围	-25℃ ~ 55℃ 没有结冰和结露				
产品标准	GB/T14048.10-2016				
保护结构	IP66(IEC 规格)				
材质	外壳: 塑料 镜头盖: 丙烯酸树脂 镜头: 丙烯酸树脂				
受光面照度	白炽灯: 小于 3000LUS. 阳光: 小于 11000LUS.				

Product model	EN18P-D1S □□ W(Z)				
Type	Retroreflective				
Detecting distance	200cm	400cm	500cm		
Detecting target	Opaque materials of Min. Φ 60mm				
Model	NPN	NO	EN18P-D1S200NAW	EN18P-D1S400NAW	EN18P-D1S500NAW
		NC	EN18P-D1S200NBWW	EN18P-D1S400NBW	EN18P-D1S500NBW
		NO+NC	EN18P-D1S200NCW	EN18P-D1S400NCW	EN18P-D1S500NCW
Model	PNP	NO	EN18P-D1S200PAW	EN18P-D1S400PAW	EN18P-D1S500PAW
		NC	EN18P-D1S200PBW	EN18P-D1S400PBW	EN18P-D1S500PBW
		NO+NC	EN18P-D1S200PCW	EN18P-D1S400PCW	EN18P-D1S500PCW
Standard sensing object	Matte white board paper 20cm × 20cm				
Response time	Move and reset less than 1ms				
Power supply	12-24VDC(10-30V)				
Light	Red light LED 660nm/ Infrared 880nm				
Ambient Temperature	-25℃ ~ +55℃ without icing and condensation				
Product Standards	GB/T14048.10-2016				
Protection	IP66(IEC Specification)				
Material	Shell: Plastic, Lens cap: Acrylic, Lens: Acrylic				
Ambient illumination	Lamp: Less than 3000LUS. Sunlight: Less than 11000LUS.				

长距离接插件式光电传感器

EN18P Through beam Type Long Distance Cable Type
Photoelectric Sensor With Connector

外形尺寸 Dimensions: M18 × 1 × 58



- 螺纹柱状光电传感器
- 具有光电-IC 技术
- 带灵敏度调节器
- 同时拥有领先的两项顶尖技术专利
- Threaded cylindrical photoelectric sensor
- Long life
- Photo-IC technology
- High Anti-Glare interference
- With sensitivity adjustment
- 长寿命
- 抗强光干扰
- 国际时尚款式

产品规格 /Specifications

产品型号	EN18P-D1E □□ W(Z)				
检测方式	对射型				
检测距离	500cm	1000cm	2000cm		
检测物体	Φ 60mm 以上的非透明体				
型号	负逻辑	常开	EN18P-D1E500NAW	EN18P-D1E1000NAW	EN18P-D1E2000NAW
		常闭	EN18P-D1E500NBW	EN18P-D1E1000NBW	EN18P-D1E2000NBW
		一开一闭	EN18P-D1E500NCW	EN18P-D1E1000NCW	EN18P-D1E2000NCW
型号	正逻辑	常开	EN18P-D1E500PAW	EN18P-D1E1000PAW	EN18P-D1E2000PAW
		常闭	EN18P-D1E500PBW	EN18P-D1E1000PBW	EN18P-D1E2000PBW
		一开一闭	EN18P-D1E500PCW	EN18P-D1E1000PCW	EN18P-D1E2000PCW
标准检测物	无光泽白板纸 20cm × 20cm				
响应时间	无移动和复位小于 1ms				
电源电压	12-24VDC(10-30V)				
光源	红外光 LED660nm/ 红外线 880nm				
使用温度范围	-25℃ ~ 55℃ 没有结冰和结露				
产品标准	GB/T14048.10-2016				
保护结构	IP66(IEC 规格)				
材质	外壳: 塑料 镜头盖: 丙烯酸树脂 镜头: 丙烯酸树脂				
受光面照度	白炽灯: 小于 3000LUS. 阳光: 小于 11000LUS.				

Product model	EN18P-D1E □□ W(Z)				
Type	Opposite type (Through beam type)				
Detecting distance	500cm	1000cm	2000cm		
Detecting target	Opaque materials of Min. Φ 60mm				
Model	NPN	NO	EN18P-D1E500NAW	EN18P-D1E1000NAW	EN18P-D1E2000NAW
		NC	EN18P-D1E500NBW	EN18P-D1E1000NBW	EN18P-D1E2000NBW
		NO+NC	EN18P-D1E500NCW	EN18P-D1E1000NCW	EN18P-D1E2000NCW
Model	PNP	NO	EN18P-D1E500PAW	EN18P-D1E1000PAW	EN18P-D1E2000PAW
		NC	EN18P-D1E500PBW	EN18P-D1E1000PBW	EN18P-D1E2000PBW
		NO+NC	EN18P-D1E500PCW	EN18P-D1E1000PCW	EN18P-D1E2000PCW
Standard sensing object	Matte white board paper 20cm × 20cm				
Response time	Move and reset less than 1ms				
Power supply	12-24VDC(10-30V)				
Light	Infrared LED 660nm/ Infrared 880nm				
Ambient Temperature	-25℃ ~ +55℃ without icing and condensation				
Product Standards	GB/T14048.10-2016				
Protection	IP66(IEC Specification)				
Material	Shell: Plastic, Lens cap: Acrylic, Lens: Acrylic				
Ambient illumination	Lamp: Less than 3000LUS. Sunlight: Less than 11000LUS.				

长距离宽电压系列传感器

EN50 Series Long Distance wide Voltage series sensor



- 长距离检测：比普通产品检测距离远 1 倍以上
- 新式光电 -IC 抗强光干扰
- 同时具备常开常闭输出
- 长寿命，高可靠
- Long-distance detection: One times more than normal product detection distance
- New photoelectric-IC in order to increase the Anti-glare interference
- Along with normally open and normally closed output
- Long life, high reliability

产品规格 /Specifications

产品型号	EN50-UE2000JC	EN50-US1000JC	EN50-UT200JC
检测方式	透过型	镜面反射型	漫反射型
标准检测物	无光泽白板纸 20cm × 20cm		
检测距离	2000cm	10-1000cm	200cm
检测物体	Φ16mm 以上的非透明体	Φ60mm 以上的非透明体	非透明体、半透明体、透明体
光源	红外线 880nm	红光 LED 660nm/ 红外线 880nm	
响应时间	移动和复位小于 1ms		
电源电压	AC36-240V ± 10% 50/60Hz, DC24-240V ± 10% (波纹 P-P: 10% 以下)		
调节灵敏度	-	内置调节灵敏度的 VR	
控制输出	继电器输出 <input type="checkbox"/> 批点容量 : DC 30V 3A 阻抗负载、AC 250V 3A 阻抗负载 接点组成: NO+NC		
受光面照度	白炽灯: 小于 3000LUS. 阳光: 小于 11000LUS.		
使用温度范围	-25℃ ~ +55℃ 没有结冰和结露		
材质	外壳: ABS. 镜片: PC.		
产品标准	GB/T14048.10-2016		
保护等级	IP64(IEC)		

Product model	EN50-UE2000JC	EN50-US1000JC	EN50-UT200JC
Type	Through beam type	Retroreflective(*1)	Diffuse type
Standard sensing object	Matte white board paper 20cm × 20cm		
Detecting distance	2000cm	10-1000cm	200cm
Detecting target	Opaque materials Φ16mm	Opaque materials with minimum length of Φ60mm	Non-transparent, translucent or transparent
Light	Infrared 880nm	Red light LED 660nm/ Infrared 880nm	
Response time	Move and reset less than 1ms		
Power supply	AC36-240V ± 10% 50/60Hz, DC24-240V ± 10% (Ripple P-P: 10% below)		
Sensitivity	-	Adjustable by built-in VR	
Control output	Relay output <input type="checkbox"/> Capacity: DC 30V 3A Resistive load、250VAC 3A Resistive load 10 Contact orde: NO+NC		
Ambient illumination	Lamp: Less than 3000LUS. Sunlight: Less than 11000LUS.		
Ambient Temperature	-25℃ ~ +55℃ without icing and condensation		
Material	Housing: ABS. lens: PC.		
Product Standards	GB/T14048.10-2016		
Protection	IP64(IEC)		

长距离直流电压系列传感器

EN50 Series Long Distance DC Voltage series sensor



- 长距离检测：比普通产品检测距离远 1 倍以上
- 新式光电 -IC 抗强光干扰
- 同时具备常开常闭输出
- 长寿命，高可靠
- Long-distance detection: One times more than normal product detection distance
- New photoelectric-IC in order to increase the Anti-glare interference
- Along with normally open and normally closed output
- Long life, high reliability

产品规格 / Specifications

产品型号	EN50-DIE2000JC	EN50-DIS1000JC	EN50-DIT200JC
检测方式	透过型	镜面反射型	漫反射型
标准检测物	无光泽白板纸 20cm × 20cm		
检测距离	2000cm	10-1000cm	200cm(100 × 100mm 白色无光纸)
检测物体	Φ16mm 以上的非透明体	Φ60mm 以上的非透明体	非透明体、半透明体、透明体
光源	红外线 880nm	红光 LED 660nm/ 红外线 880nm	
响应时间	移动和复位小于 1ms		
电源电压	12-24VDC(10-30VDC) 波纹 P-P:10% 以下		
调节灵敏度	-	内置调节灵敏度的 VR	
控制输出	继电器输出 <input type="checkbox"/> 批点容量 :DC 30V 3A 阻抗负载、AC 250V 3A 阻抗负载 接点组成: NO+NC		
受光面照度	白炽灯: 小于 3000LUS. 阳光: 小于 11000LUS.		
使用温度范围	-25℃ ~+55℃ 没有结冰和结露		
材质	外壳: ABS. 镜片: PC.		
产品标准	GB/T14048.10-2016		
保护等级	IP64(IEC)		

Product model	EN50-DIE2000JC	EN50-DIS1000JC	EN50-DIT200JC
Type	Through beam type	Retroreflective(*1)	Diffuse type
Standard sensing object	Matte white board paper 20cm × 20cm		
Detecting distance	2000cm	10-1000cm	200cm(100 × 100mm white paper)
Detecting target	Opaque materials Φ16mm	Opaque materials with minimum length of Φ60mm	Non-transparent, translucent or transparent
Light	Infrared 880nm	Red light LED 660nm/ Infrared 880nm	
Response time	Move and reset less than 1ms		
Power supply	12-24VDC(10-30VDC) Ripple P-P:10% below		
Sensitivity	-	Adjustable by built-in VR	
Control output	Relay output <input type="checkbox"/> Capacity:DC 30V 3A Resistive load、250VAC 3A Resistive load 10 Contact orde: NO+NC		
Ambient illumination	Lamp: Less than 3000LUS. Sunlight: Less than 11000LUS.		
Ambient Temperature	-25℃ ~+55℃ without icing and condensation		
Material	Housing: ABS. lens: PC.		
Product Standards	GB/T14048.10-2016		
Protection	IP64(IEC)		

标准距离宽电压系列传感器

EN50 Series Standard Distance wide Voltage series sensor



- 长距离检测：比普通产品检测距离远 1 倍以上
- 新式光电 -IC 抗强光干扰
- 同时具备常开常闭输出
- 长寿命，高可靠
- Long-distance detection: One times more than normal product detection distance
- New photoelectric-IC in order to increase the Anti-glare interference
- Along with normally open and normally closed output
- Long life, high reliability

产品规格 /Specifications

产品型号	EN50-UE1000JC	EN50-US500JC	EN50-UT70JC
检测方式	透过型	镜面反射型	漫反射型
标准检测物	无光泽白板纸 20cm × 20cm		
检测距离	1000cm	5-500cm	70cm
检测物体	Φ16mm 以上的非透明体	Φ60mm 以上的非透明体	非透明体、半透明体、透明体
光源	红外线 880nm	红光 LED660nm/ 红外线 880nm	
响应时间	移动和复位小于 1ms		
电源电压	AC36-240V ± 10%50/60Hz,DC24-240V ± 10%(波纹 P-P:10% 以下)		
调节灵敏度	-	内置调节灵敏度的 VR	
控制输出	继电器输出 <input type="checkbox"/> 批点容量 :DC 30V 3A 阻抗负载、AC 250V 3A 阻抗负载 接点组成: NO+NC		
受光面照度	白炽灯: 小于 3000LUS. 阳光: 小于 11000LUS.		
使用温度范围	-25℃ ~+55℃ 没有结冰和结露		
材质	外壳: ABS. 镜片: PC.		
产品标准	GB/T14048.10-2016		
保护等级	IP64 (IEC 规格)		

Product model	EN50-UE1000JC	EN50-US500JC	EN50-UT70JC
Type	Through beam type	Retroreflective(*1)	Diffuse type
Standard sensing object	Matte white board paper 20cm × 20cm		
Detecting distance	1000cm	5-500cm	70cm
Detecting target	Opaque materials Φ16mm	Opaque materials with minimum length of Φ60mm	Non-transparent, translucent or transparent
Light	Infrared 880nm	Red light LED 660nm/ Infrared 880nm	
Response time	Move and reset less than 1ms		
Power supply	AC36-240V ± 10%50/60Hz,DC24-240V ± 10%(Ripple P-P:10% below)		
Sensitivity	-	Adjustable by built-in VR	
Control output	Relay output <input type="checkbox"/> Capacity:DC 30V 3A Resistive load、250VAC 3A Resistive load 10 Contact orde: NO+NC		
Ambient illumination	Lamp: Less than 3000LUS. Sunlight: Less than 11000LUS.		
Ambient Temperature	-25℃ ~+55℃ without icing and condensation		
Material	Housing: ABS. lens: PC.		
Product Standards	GB/T14048.10-2016		
Protection	IP64 (IEC Standard)		

标准距离直流电压系列传感器

EN50 Series Standard distance DC Voltage series sensor



- 新式光电-IC 抗强光干扰性
- 同时具备常开常闭输出
- 长寿命, 高可靠

- New photoelectric-IC in order to increase the Anti-glare interference
- Along with normally open and normally closed output
- Long life, high reliability

产品规格 /Specifications

产品型号	EN50-D1E1000JC	EN50-D1S500JC	EN50-D1T70JC
检测方式	透过型	镜面反射型	漫反射型
标准检测物	无光泽白板纸 20cm × 20cm		
检测距离	1000cm	5-500cm	70cm
检测物体	Φ16mm 以上的非透明体	Φ60mm 以上的非透明体	非透明体、半透明体、透明体
光源	红外线 880nm	红光 LED660nm/ 红外线 880nm	
响应时间	移动和复位小于 1ms		
电源电压	AC36-240V ± 10% 50/60Hz, DC24-240V ± 10% (波纹 P-P: 10% 以下)		
调节灵敏度	-	内置调节灵敏度的 VR	
控制输出	继电器输出 <input type="checkbox"/> 批点容量 : DC 30V 3A 阻抗负载、AC 250V 3A 阻抗负载 接点组成: NO+NC		
受光面照度	白炽灯: 小于 3000LUS. 阳光: 小于 11000LUS.		
使用温度范围	-25℃ ~ +55℃ 没有结冰和结露		
材质	外壳: ABS. 镜片: PC.		
产品标准	GB/T14048.10-2016		
保护等级	IP64 (IEC 规格)		

Product model	EN50-D1E1000JC	EN50-D1S500JC	EN50-D1T70JC
Type	Through beam type	Retroreflective(*1)	Diffuse type
Standard sensing object	Matte white board paper 20cm × 20cm		
Detecting distance	1000cm	5-500cm	70cm
Detecting target	Opaque materials Φ16mm	Opaque materials with minimum length of Φ60mm	Non-transparent, translucent or transparent
Light	Infrared 880nm	Red light LED 660nm/ Infrared 880nm	
Response time	Move and reset less than 1ms		
Power supply	AC36-240V ± 10% 50/60Hz, DC24-240V ± 10% (Ripple P-P: 10% below)		
Sensitivity	-	Adjustable by built-in VR	
Control output	Relay output <input type="checkbox"/> Capacity: DC 30V 3A Resistive load、250VAC 3A Resistive load 10 Contact orde: NO+NC		
Ambient illumination	Lamp: Less than 3000LUS. Sunlight: Less than 11000LUS.		
Ambient Temperature	-25℃ ~ +55℃ without icing and condensation		
Material	Housing: ABS. lens: PC.		
Product Standards	GB/T14048.10-2016		
Protection	IP64 (IEC Standard)		

光电传感器支架 /Holder

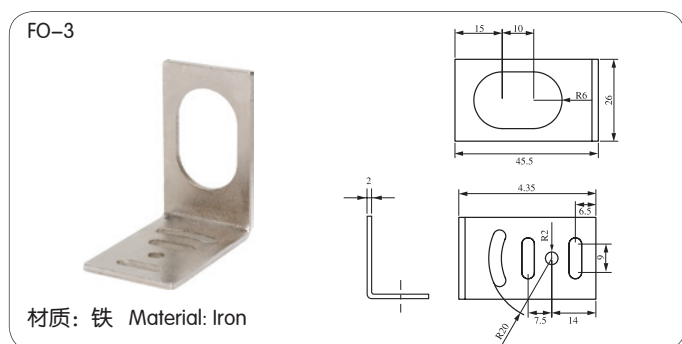
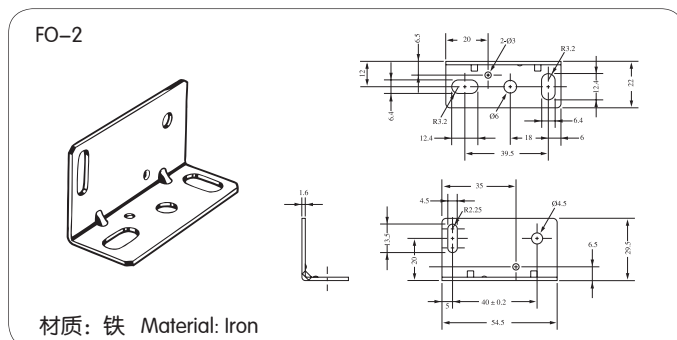
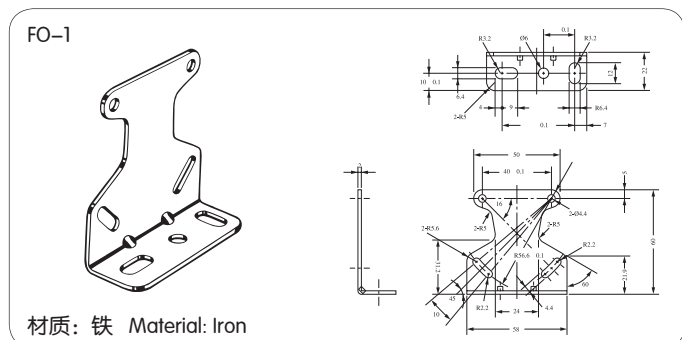

TD 镜面反射板及其工作原理 /TD Mirror Reflector Plate And Working Principle

With the built-in polarization filter and retro-reflective characteristics, the retro-reflective type photoelectric sensor only receive the beam returned from the reflector plate.

镜面抑制 (M.S.R) 功能

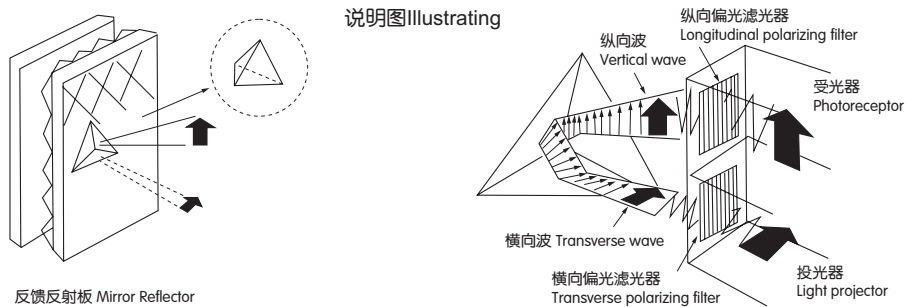

TD 镜面反射板 /TD Mirror Reflector Plate

